

VIEW7 (1 : 10)

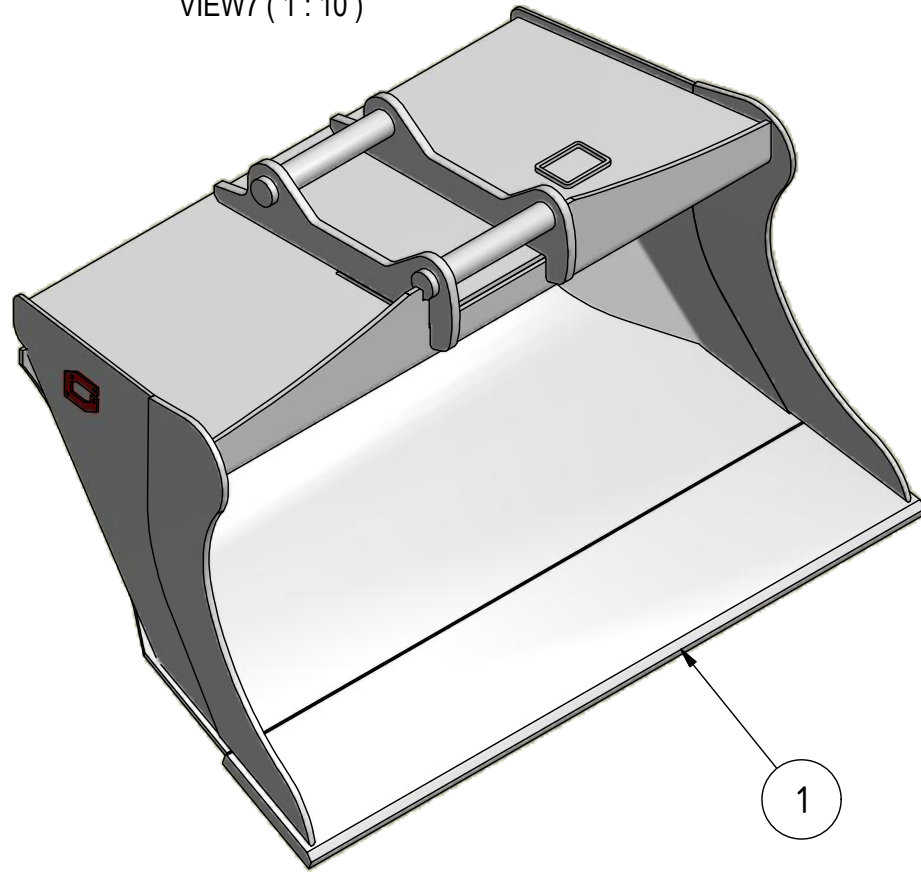

VIEW5 (1 : 7.5)

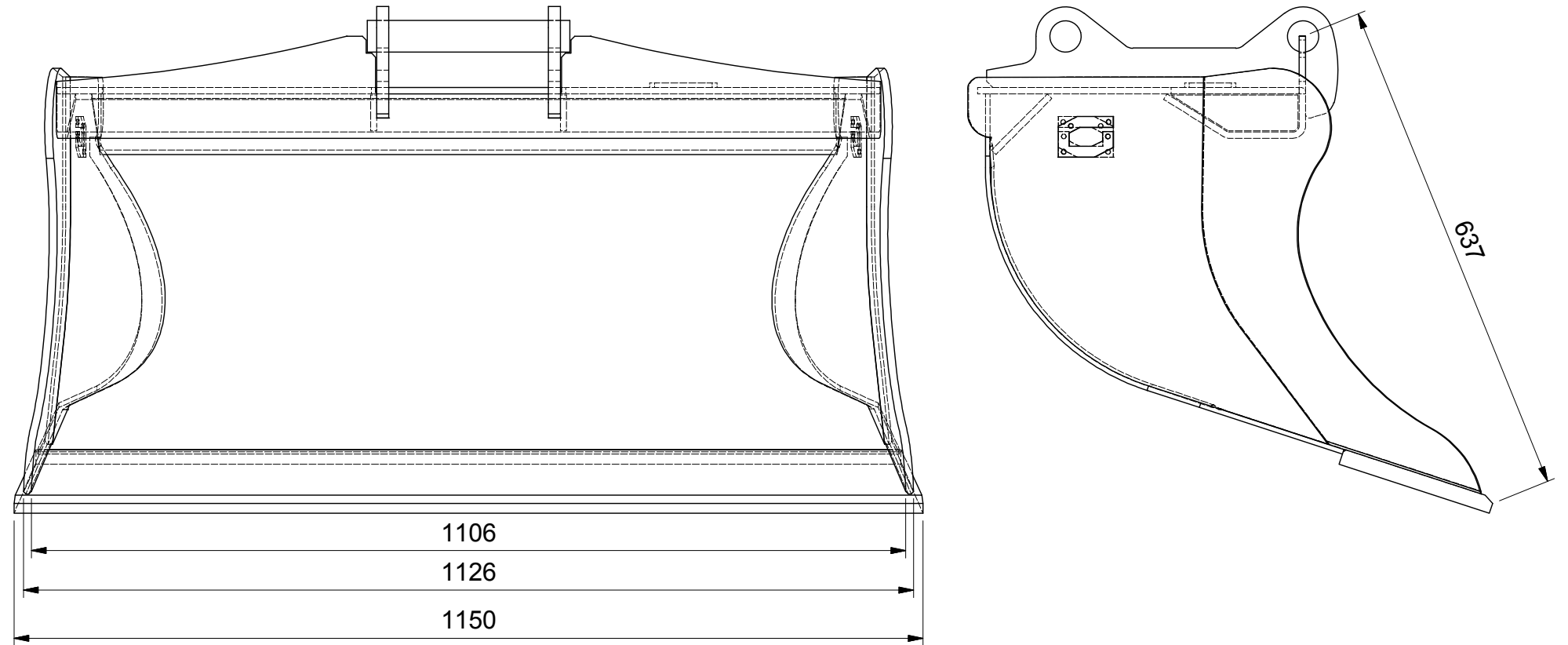

VIEW8 (1 : 10)

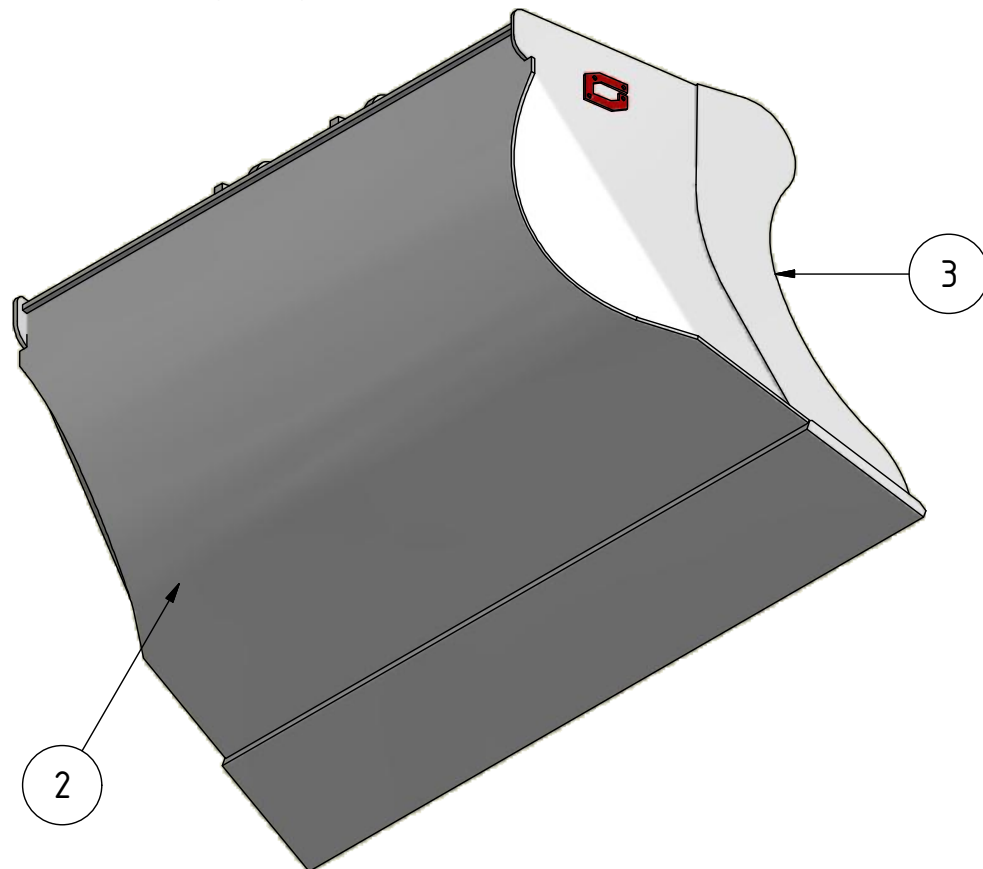

Recommended machine weight: 3-4 T

SPECIFICATION			
POS	TITLE	MATERIAL	DESCRIPTION
1.	FRONT EDGE	HB450	20x200x1150mm
2.	BOTTOM PLATE	HB450	6mm
3.	SIDE MEMBER	HB450	10mm
4.			
5.			
6.			

GENERAL TOLERANCES
For non tolerance measurements

Denne tegning og konstruksjon er vår eiendom, og tillates IKKE kopiert eller benyttet uten vår tillatelse.
Overtredelse vil kunne medføre straff og/eller erstatningsansvar i henhold til gjeldende lov.
This drawing and design is our property, and NOT allowed copied or used without our permission.
Any misuse can lead to prosecution and/or liability for compensation according to law.

MACHINED PARTS:
NS-ISO 2768-1
Grade: m

GJERSTAD STD SLOPE BUCKET 185L S40

Scale:

A3

Projection:

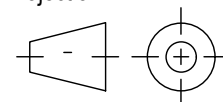

Date: 20-Apr-15

Draw.: PR

Contr.:

WELDED CONSTRUCTIONS:
NS-EN ISO 13920
1. Linear measurements class: A
2. Angle measurements class: B
3. Straightness etc. class: F



Gjerstad Engineering AS
Brokelandsheia, N-4993 sundebru
www.gjerstad.com

Draw.no.:

GE3309-A-SALE

Total weight: 149 kg

Revision: