

VIEW7 (1 : 10)

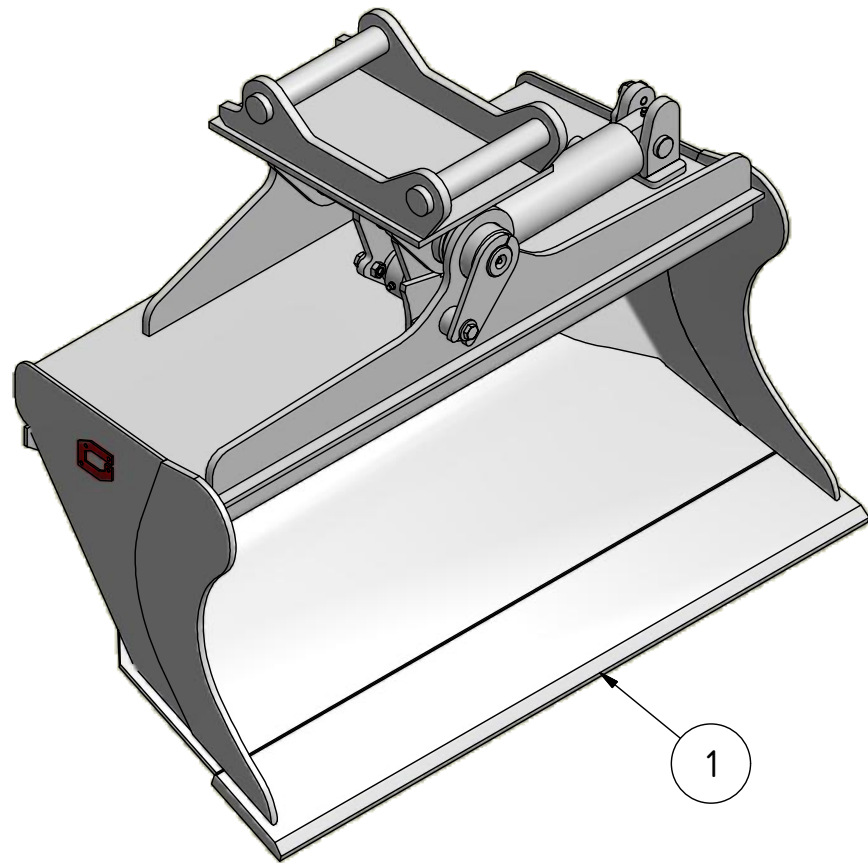

VIEW5 (1 : 7.5)

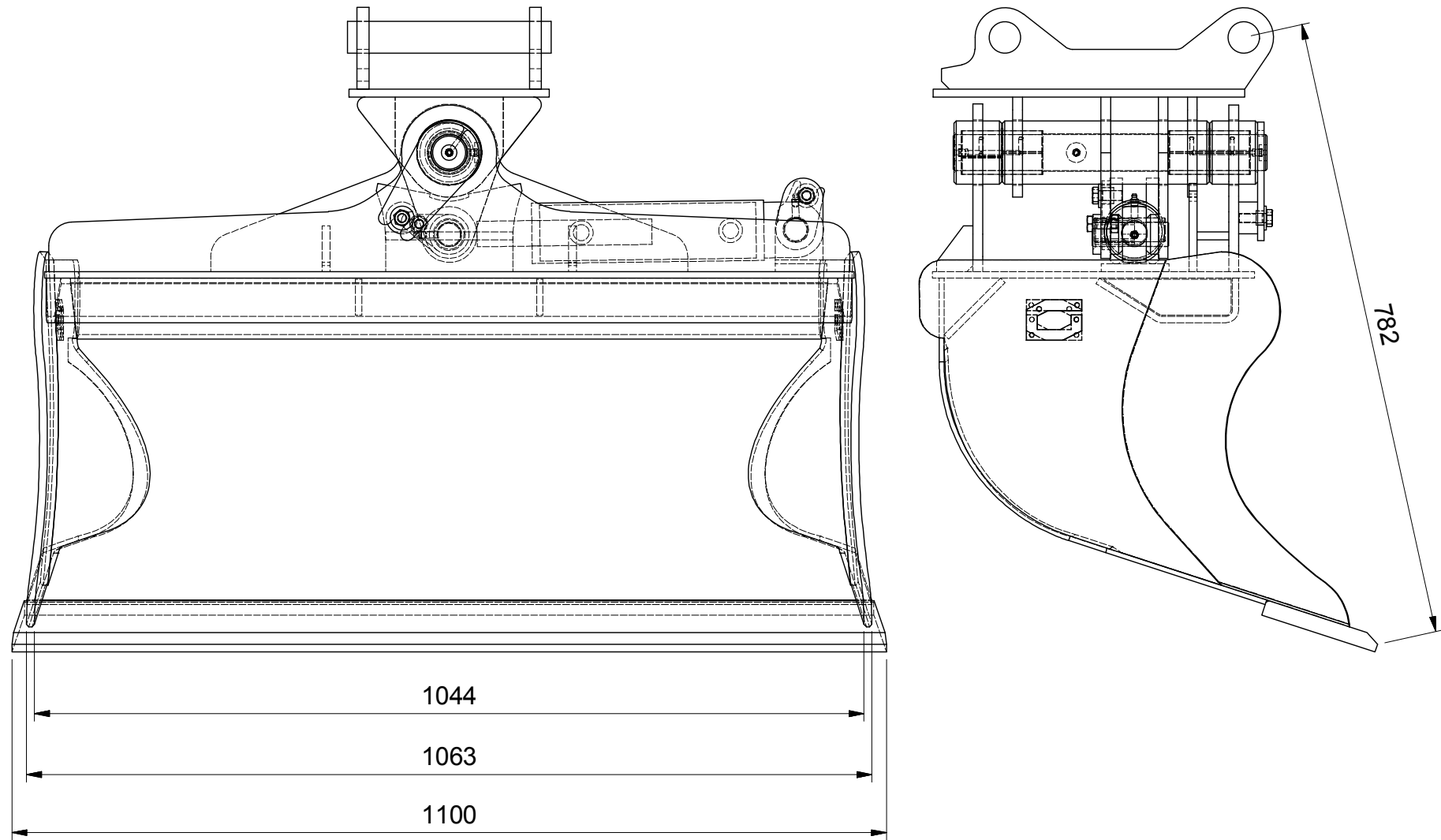

VIEW8 (1 : 10)

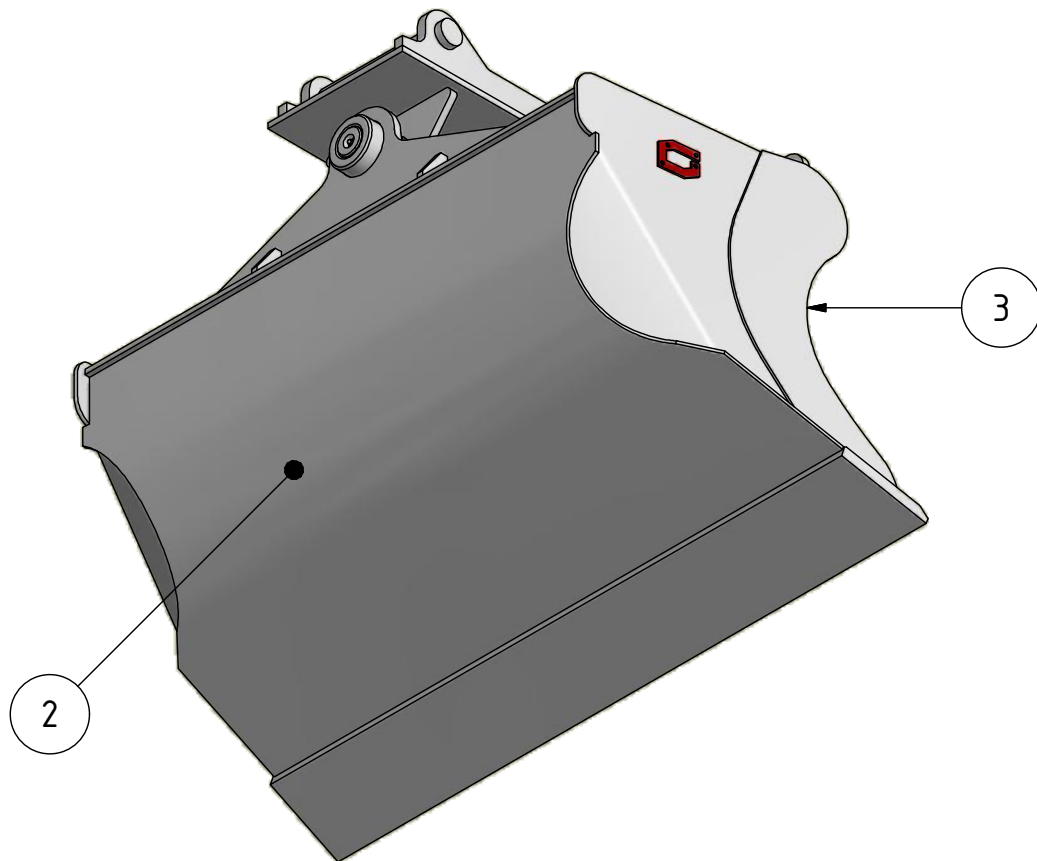

**Recommended machine weight:** 3-4 T

SPECIFICATION			
POS	TITLE	MATERIAL	DESCRIPTION
1.	FRONT EDGE	HARDOX 450	20x150x1100mm
2.	BOTTOM PLATE	HARDOX 450	6mm
3.	SIDE MEMBER	HARDOX 450	10mm
4.			
5.			
6.			

GENERAL TOLERANCES  
For non tolerance measurements

Denne tegning og konstruksjon er vår eiendom, og tillates IKKE kopiert eller benyttet uten vår tillatelse.  
Overtredelse vil kunne medføre straff og/eller erstatningsansvar i henhold til gjeldende lov.  
This drawing and design is our property, and NOT allowed copied or used without our permission.  
Any misuse can lead to prosecution and/or liability for compensation according to law.

MACHINED PARTS:  
NS-ISO 2768-1  
Grade: m

GJERSTAD STD HYD SLOPE BUCKET 150L  
S40

Scale:

A3

Projection:

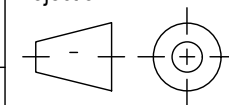

Date: 20-Apr-15

Draw.: PR

Contr.:

WELDED CONSTRUCTIONS:  
NS-EN ISO 13920  
1. Linear measurements class: A  
2. Angle measurements class: B  
3. Straightness etc. class: F



**Gjerstad Engineering AS**  
Brokelandsheia, N-4993 sundebru  
www.gjerstad.com

Draw.no.:

**GE3405-SALE**

Total weight: 182 kg

Revision: